

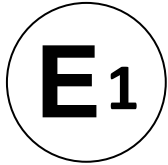

# Kraftfahrt-Bundesamt

DE-24932 Flensburg

---



## MITTEILUNG

ausgestellt von:

**Kraftfahrt-Bundesamt**

über die Erteilung einer Genehmigung  
für einen Typ einer mechanischen Verbindungseinrichtung oder eines  
mechanischen Verbindungsbauteils nach der Regelung Nr. R55  
einschließlich Änderung Nr. 02 Ergänzung 02

## COMMUNICATION

issued by:

**Kraftfahrt-Bundesamt**

concerning the granting of an approval  
of a type of mechanical coupling device or component pursuant to  
Regulation No. R55 including amendment No 02 supplement 02

Genehmigungsnummer: **E1\*55R02/02\*3343\*00**

Approval number:

1. Fabrik- oder Handelsmarke der Einrichtung oder des Bauteils:  
Trade name or mark of the device or component:  
**WAP Fahrzeugtechnik GmbH**
2. Typ der Einrichtung oder des Bauteils:  
Type of device or component:  
**WFK 50**  
  
Ausführung(en):  
Version(s):  
**Entfällt**  
**Not applicable**
3. Name und Anschrift des Herstellers:  
Manufacturer's name and address:  
**WAP Fahrzeugtechnik GmbH**  
**DE-33178 Borcheln**



# Kraftfahrt-Bundesamt

DE-24932 Flensburg

---

2

Genehmigungsnummer: **E1\*55R02/02\*3343\*00**

Approval number:

4. Gegebenenfalls Name und Anschrift des Vertreters des Herstellers:  
If applicable, name and address of manufacturer's representative:  
**Entfällt**  
**Not applicable**
5. Namen oder Handelsmarken anderer Lieferanten, mit denen die Einrichtung oder das Bauteil gekennzeichnet ist:  
Alternative supplier's names or trade marks applied to the device or component:  
**Entfällt**  
**Not applicable**
6. Name und Anschrift des Unternehmens oder der Gesellschaft, die für die Übereinstimmung der Produktion verantwortlich ist:  
Name and address of company or body taking responsibility for the conformity of production:  
**WAP Fahrzeugtechnik GmbH**  
**DE-33178 Borchen**
7. Zur Genehmigung vorgelegt am:  
Submitted for approval on:  
**09.09.2022**
8. Technischer Dienst, der die Prüfungen für die Genehmigung durchführt:  
Technical service responsible for conducting approval tests:  
**TÜV SÜD Auto Service GmbH**  
**DE-80686 München**
9. Kurzbeschreibung:  
Brief description:
  - 9.1. Typ und Klasse der Einrichtung oder des Bauteils:  
Type and class of device or component:  
**Nicht genormte Kupplungskugel der Klasse A50-X**  
**Non-standard coupling ball pursuant to class A50-X**



# Kraftfahrt-Bundesamt

DE-24932 Flensburg

3

Genehmigungsnummer: **E1\*55R02/02\*3343\*00**  
Approval number:

9.2. Kennwerte:  
Characteristic values:

9.2.1. Hauptwerte:  
Primary values:

D (kN): <b>31</b>	D <sub>c</sub> (kN): <b>31</b>	S (kg): <b>350</b>
----------------------	-----------------------------------	-----------------------

U (t): <b>Entfällt</b> <b>Not applicable</b>	V (kN): <b>Entfällt</b> <b>Not applicable</b>
--	---

Alternativwerte:  
Alternative values:

D (kN): <b>Entfällt</b> <b>Not applicable</b>	D <sub>c</sub> (kN): <b>Entfällt</b> <b>Not applicable</b>	S (kg): <b>Entfällt</b> <b>Not applicable</b>
---	--	---

U (t): <b>Entfällt</b> <b>Not applicable</b>	V (kN): <b>Entfällt</b> <b>Not applicable</b>
--	---

9.3. Bei mechanischen Verbindungseinrichtungen oder –bauteilen der Klasse A, einschließlich Kupplungshalterungen  
For Class A mechanical coupling devices or components, including towing brackets

Höchstzulässige Fahrzeugmasse gemäß Fahrzeugherstellerangaben (kg):  
Vehicle manufacturer's maximum permissible vehicle mass (kg):  
**32000**

Verteilung der höchstzulässigen Fahrzeugmasse auf die Achsen (kg):  
Distribution of maximum permissible vehicle mass between axles (kg):  
**VA: Max. 10000**  
**HA: Max. 32000**

Höchstzulässige Anhängelast gemäß Fahrzeugherstellerangaben (kg):  
Vehicle manufacturer's maximum permissible towable trailer mass (kg):  
**3500**

Höchstzulässige statische Stützlast an der Kupplungskugel gemäß Fahrzeugherstellerangaben (kg):  
Vehicle manufacturer's maximum permissible static vertical load on coupling ball (kg):  
**350**



# Kraftfahrt-Bundesamt

DE-24932 Flensburg

4

Genehmigungsnummer: **E1\*55R02/02\*3343\*00**

Approval number:

Höchstmasse des betriebsbereiten Fahrzeugs mit Aufbau, einschließlich Kühlmittel, Ölen, Kraftstoff, Werkzeugen und Reserverad (falls vorhanden), aber ohne Fahrzeugführer (kg):

Maximum mass of the vehicle, with bodywork, in running order, including coolant, oils, fuel, tools and spare wheel (if supplied) but not including driver (kg):

**Siehe Fahrzeugherstellangaben, abhängig vom Fahrzeuggesamtgewicht.  
See vehicle manufacturer's specifications, depending on vehicle weight.**

Beladungszustand, bei dem bei Fahrzeugen der Klasse M<sub>1</sub> die Höhe der Kupplungskugel einer mechanischen Verbindungseinrichtung über dem Boden zu messen ist – siehe Abschnitt 2 der Anlage 1 zum Anhang 7:

Loading condition under which the tow ball height of a mechanical coupling device fitted to category M<sub>1</sub> vehicles is to be measured – see paragraph 2 of annex 7, appendix 1:

**Der Beladungszustand ist nach ECE-R55, Anhang 7, Anlage 1 ermittelt worden. Es ist der Beladungszustand, bei dem bei Fahrzeugen der Klasse M1 die Höhe der Kupplungskugel einer mechanischen Verbindungseinrichtung über dem Boden zu messen ist – Kugelmittelpunkt zur Fahrbahn  $350 < x < 420$  mm.**

**The loading condition is found according to ECE-R55 Annex 7, Appendix 1. It is the loading condition at which the height of the tow ball of M1 category vehicles is to be measured - central point of the tow ball to the road surface  $350 < x < 420$  mm.**

- 9.4. Bei Kupplungsköpfen der Klasse B ist der Kupplungskopf für die Anbringung an einem ungebremsten Anhänger der Klasse O<sub>1</sub> bestimmt:  
For class B coupling heads, is the coupling head intended to be fitted to an unbraked O<sub>1</sub> trailer:

**Entfällt**

**Not applicable**

10. Anweisungen des Fahrzeugherstellers für den Anbau der Verbindungseinrichtung oder des Verbindungsbauteils an das Fahrzeug und Fotografien oder Zeichnungen der Befestigungspunkte:

Instructions for the attachment of the coupling device or component type to the vehicle and photographs or drawings of the mounting points given by the vehicle manufacturer:

**Siehe Montage- und Betriebsanleitung**

**See installation and operating instructions**

11. Angaben über die Befestigung besonderer Verstärkungshalterungen oder –platten oder Abstandhalter, die für den Anbau der Verbindungseinrichtung oder des Verbindungsbauteils erforderlich sind:

Information on the fitting of any special reinforcing brackets or plates or spacing components necessary for the attachment of the coupling device or component:

**Siehe Montage- und Betriebsanleitung**

**See installation and operating instructions**



# Kraftfahrt-Bundesamt

DE-24932 Flensburg

---

5

Genehmigungsnummer: **E1\*55R02/02\*3343\*00**  
Approval number:

12. Zusätzliche Angaben für den Fall, dass die Verwendung der Verbindungseinrichtung oder des Verbindungsbauteils auf bestimmte Fahrzeugtypen eingeschränkt ist – siehe 3.4. des Anhangs 5:  
Additional information where the use of the coupling device or component is restricted to special types of vehicles – see annex 5, paragraph 3.4.:  
**Siehe Beschreibungsmappe**  
**See information document**
13. Bei Hakenkupplungen der Klasse K: genaue Angaben zu den Zugösen, die für die Verwendung mit dem jeweiligen Hakentyp geeignet sind:  
For Class K hook type couplings, details of the drawbar eyes suitable for use with the particular hook type:  
**Entfällt**  
**Not applicable**
14. Datum des Gutachtens:  
Date of test report:  
**09.09.2022**
15. Nummer des Gutachtens:  
Number of test report:  
**22-00324-CX-GBM**
16. Stelle, an der das Genehmigungszeichen angebracht ist:  
Approval mark position:  
**Kupplungskugel oben**  
**At the top of the ball coupling**
17. Grund (Gründe) für die Erweiterung der Genehmigung:  
Reason(s) for extension of approval:  
**Entfällt**  
**Not applicable**



# Kraftfahrt-Bundesamt

DE-24932 Flensburg

6

Genehmigungsnummer: **E1\*55R02/02\*3343\*00**  
Approval number:

18. Die Genehmigung wird **erteilt**  
Approval is **granted**
19. Ort: **DE-24932 Flensburg**  
Place:
20. Datum: **12.09.2022**  
Date:
21. Unterschrift: **Im Auftrag**  
Signature:

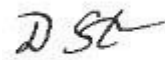
  
(D. Stieglitz)



22. Die Liste der Unterlagen, die bei der Genehmigungsbehörde hinterlegt und auf Anfrage erhältlich sind, liegt dieser Mitteilung bei  
The list of documents deposited with the Administration Service which has granted approval is annexed to this communication and may be obtained on request

Anlagen:  
Enclosures:  
**Gemäß Inhaltsverzeichnis**  
**According to index**

23. Bemerkungen:  
Remarks:  
**Entfällt**  
**Not applicable**



# Kraftfahrt-Bundesamt

DE-24932 Flensburg

---

Zu: E1\*55R02/02\*3343\*00

To:

**Erklärung über die Einhaltung der Anforderungen hinsichtlich der Übereinstimmung  
der Produktion gemäß dem Übereinkommen von 1958**  
**Statement of compliance with the conformity of the production requirements of the  
1958 Agreement**

1. Name des Herstellers:  
Manufacturer's name:  
**WAP Fahrzeugtechnik GmbH**  
**DE-33178 Borcheln**
  
2. Datum der Anfangsbewertung:  
Date of the initial assessment:  
**30.01.2001**
  
3. Datum aller durchgeführten Überwachungstätigkeiten:  
Date of any surveillance activities:  

Aktenzeichen	Datum der Begehung	Genehmigungsnummer
Register number	Date of inspection	Approval number

  
CoP-Q:  
**Entfällt**  
**Not applicable**  
  
CoP-P:  
**Entfällt**  
**Not applicable**



# Kraftfahrt-Bundesamt

DE-24932 Flensburg

---

Zu: **E1\*55R02/02\*3343\*00**

To:

## Inhaltsverzeichnis zu den Beschreibungsunterlagen Index to the information package

Ausgabedatum: **12.09.2022**                      Letztes Änderungsdatum: **--**  
Date of issue:    Last date of amendment:

Nebenbestimmungen und Rechtsbehelfsbelehrung  
Collateral clauses and instruction on right to appeal

Prüfbericht(e) Nr.:    Datum:  
Test report(s) No.:    Date:  
**22-00324-CX-GBM**    **09.09.2022**

Beschreibungsbogen Nr.:    Datum:  
Information document No.:    Date:  
**WFK 50**    **08.09.2022**

Liste der Änderungen:    Datum:  
List of modifications:    Date:  
**Entfällt**  
**Not applicable**

R55 E1\*55R02/02\*3343\*00





# Kraftfahrt-Bundesamt

DE-24932 Flensburg

---

Nummer der Genehmigung: **E1\*55R02/02\*3343\*00**

- Anlage -

## Nebenbestimmungen und Rechtsbehelfsbelehrung

### Nebenbestimmungen

Jede Einrichtung, die dem genehmigten Typ entspricht, ist gemäß der angewendeten Vorschrift zu kennzeichnen.

Die Einzelerzeugnisse der reihenweisen Fertigung müssen mit den Genehmigungsunterlagen genau übereinstimmen. Änderungen an den Einzelerzeugnissen sind nur mit ausdrücklicher Zustimmung des Kraftfahrt-Bundesamtes gestattet.

Änderungen der Firmenbezeichnung, der Anschrift und der Fertigungsstätten sowie eines bei der Erteilung der Genehmigung benannten Zustellungsbevollmächtigten oder bevollmächtigten Vertreters sind dem Kraftfahrt-Bundesamt unverzüglich mitzuteilen.

Verstöße gegen diese Bestimmungen können zum Widerruf der Genehmigung führen und können überdies strafrechtlich verfolgt werden.

Die Genehmigung erlischt, wenn sie zurückgegeben oder entzogen wird, oder der genehmigte Typ den Rechtsvorschriften nicht mehr entspricht. Der Widerruf kann ausgesprochen werden, wenn die für die Erteilung und den Bestand der Genehmigung geforderten Voraussetzungen nicht mehr bestehen, wenn der Genehmigungsinhaber gegen die mit der Genehmigung verbundenen Pflichten - auch soweit sie sich aus den zu dieser Genehmigung zugeordneten besonderen Auflagen ergeben - verstößt oder wenn sich herausstellt, dass der genehmigte Typ den Erfordernissen der Verkehrssicherheit oder des Umweltschutzes nicht entspricht.

Das Kraftfahrt-Bundesamt kann jederzeit die ordnungsgemäße Ausübung der durch diese Genehmigung verliehenen Befugnisse, insbesondere die genehmigungsgerechte Fertigung sowie die Maßnahmen zur Übereinstimmung der Produktion, nachprüfen. Es kann zu diesem Zweck Proben entnehmen oder entnehmen lassen. Dem Kraftfahrt-Bundesamt und/oder seinen Beauftragten ist ungehinderter Zutritt zu Produktions- und Lagerstätten zu gewähren.

Die mit der Erteilung der Genehmigung verliehenen Befugnisse sind nicht übertragbar. Schutzrechte Dritter werden durch diese Genehmigung nicht berührt.

### Rechtsbehelfsbelehrung

Gegen diese Genehmigung kann innerhalb eines Monats nach Bekanntgabe Widerspruch erhoben werden. Der Widerspruch ist beim **Kraftfahrt-Bundesamt, Fördestraße 16, DE-24944 Flensburg**, schriftlich oder zur Niederschrift einzulegen.



# Kraftfahrt-Bundesamt

DE-24932 Flensburg

---

2

Approval No.: **E1\*55R02/02\*3343\*00**

- Attachment -

## **Collateral clauses and instruction on right to appeal**

### **Collateral clauses**

All equipment which corresponds to the approved type is to be identified according to the applied regulation.

The individual production of serial fabrication must be in exact accordance with the approval documents. Changes in the individual production are only allowed with express consent of the Kraftfahrt-Bundesamt.

Changes in the name of the company, the address and the manufacturing plant as well as one of the parties given the authority to delivery or authorised representative named when the approval was granted is to be immediately disclosed to the Kraftfahrt-Bundesamt.

Breach of this regulation can lead to recall of the approval and moreover can be legally prosecuted.

The approval expires if it is returned or withdrawn or if the type approved no longer complies with the legal requirements. The revocation can be made if the demanded requirements for issuance and the continuance of the approval no longer exist, if the holder of the approval violates the duties involved in the approval, also to the extent that they result from the assigned conditions to this approval, or if it is determined that the approved type does not comply with the requirements of traffic safety or environmental protection.

The Kraftfahrt-Bundesamt may check the proper exercise of the conferred authority taken from this approval at any time. In particular this means the compliant production as well as the measures for conformity of production. For this purpose samples can be taken or have taken. The employees or the representatives of the Kraftfahrt-Bundesamt may get unhindered access to the production and storage facilities.

The conferred authority contained with issuance of this approval is not transferable. Trade mark rights of third parties are not affected with this approval.

### **Instruction on right to appeal**

This approval can be appealed within one month after notification. The appeal is to be filed in writing or as a transcript at the **Kraftfahrt-Bundesamt, Fördestraße 16, DE-24944 Flensburg.**

**Montageanleitung für Kugelkupplung Typ: WFK 50**  
**ECE - Typgenehmigung E1-55R-023343**

**1. Technische Daten:**

- Kugeldurchmesser : 50 mm
  - Kupplungsklasse : A 50-X
  - zul. D- Wert : 31 kN
  - zul. Stützlast (max. vertikale Last) : 350 kg
- d = Gewinde- Nenndurchmesser  
P = Gewinde- Steigung

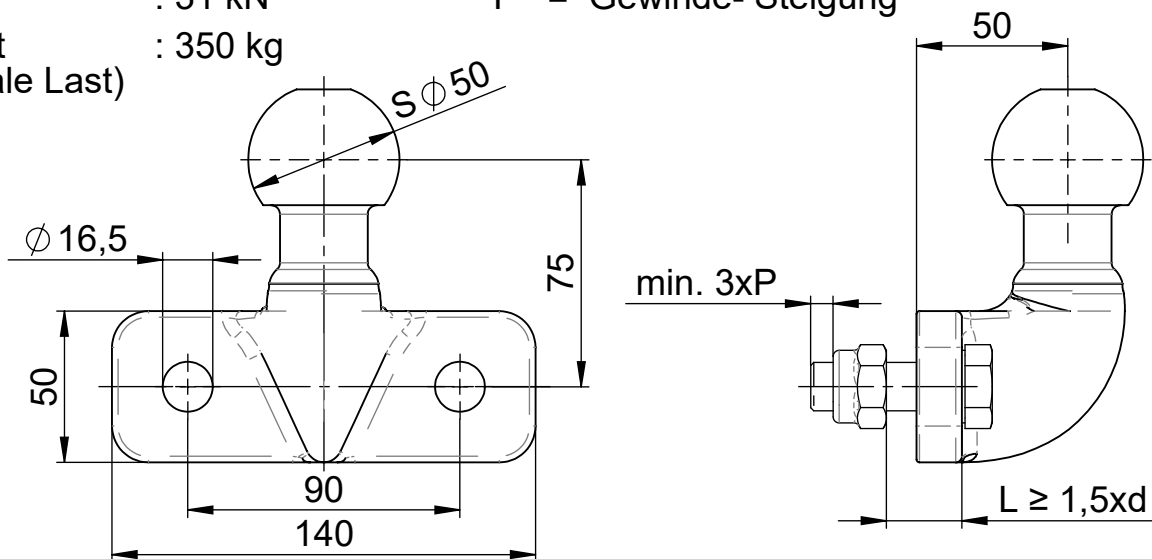

**2. Montage:**

Zu verwendende Verschraubungen:  
(Pro Kugelkupplung jeweils 2 Verschraubungen)

Schrauben	Größe	Festigkeit	Norm	Muttern	Größe	Festigkeit	Norm	MA [Nm]
6kt.-Schrauben	M16	10.9	DIN 931 / DIN 933 ISO 4014 / ISO 4017 EN 24014 / EN 24017 oder gleichwertig	6kt.-Muttern	M16	10.	DIN 980 DIN 6925 ISO 7042 oder gleichwertig	280
	M16x1,5		DIN 960 / DIN 961 ISO 8765 / ISO 8676 oder gleichwertig		M16x1,5		DIN 980 DIN 6925 ISO 10513 oder gleichwertig	
Flanschkopfschrauben	M16x1,5		DIN 6921 EN 1665 oder gleichwertig	Flanschkopfmuttern	M16x1,5		DIN 6927 EN 1667 oder gleichwertig	250 <sup>+10</sup> <sub>0</sub>

Der Freiraum nach ECE R55, Anhang 7 ist bei der Montage zu beachten.

**3. Wartung:**

Die Verschraubungen sind nach den ersten 1.000 km auf festen Sitz zu prüfen und gegebenenfalls mit den angegebenen Anziehdrehmomenten nachzuziehen. Danach alle 20.000 km.  
Vor jeder Fahrt wird geraten, die Kugelkupplung und Verschraubung auf Beschädigungen, Verschleiß und festen Sitz visuell zu überprüfen.

**4. Allgemein:**

Abweichungen von dieser Montageanleitung sind nur mit Genehmigung der WAP Fahrzeugtechnik GmbH, oder eines amtlich anerkannten Sachverständigen zulässig.  
Bei der Montage sind die Aufbauzeichnungen des Fahrzeugherstellers zu beachten.  
Schweißungen an der Kugelkupplung sind nicht zulässig.  
Die Arbeitssicherheit bei der Montage ist zu beachten.

		Datum	Name
Nummer	Bearb.	07.09.2022	Schlüter
<b>MA-234</b>	Prüfer	08.09.2022	Schneider

E6

**Mededeling betreffende de<sup>1</sup> :**

*Communication concerning <sup>1</sup>:*

- goedkeuring

- approval granted

~~- uitbreiding van de goedkeuring~~

~~- approval extended~~

~~- weigering van de goedkeuring~~

~~- approval refused~~

~~- intrekking van de goedkeuring~~

~~- approval withdrawn~~

~~- definitieve stopzetting van de productie~~

~~- production definitely discontinued~~

**van een type mechanische koppelinrichting of een onderdeel ervan  
krachtens reglement nr. 55.**

*of a type of mechanical coupling device or component pursuant to Regulation  
No 55.*

Goedkeuring nr. : E6\*55R02/00\*1713\*00  
*Approval N°*

Uitbreiding nr. : 00  
*Extension N°*

- |    |   |  |
|----|---|--|
| 1. | Handelsnaam of -merk van de inrichting of het onderdeel :<br><i>Trade name or mark of the device or component :</i>                             | ALMIC  |
| 2. | Typeaanduiding van de fabrikant :<br><i>Manufacturer's name for the type of device :</i>  | BBV  |
| 3. | Naam en adres van de fabrikant :<br><i>Manufacturer's name and address :</i>  | ALMIC BV<br>Bosuilstraat 7<br>B-3910 Pelt (Neerpelt) |
| 4. | Eventueel naam en adres van de vertegenwoordiger van de fabrikant :<br><i>If applicable, name and address of manufacturer's representative:</i> | -  |

<sup>1</sup> Doorhalen wat niet van toepassing is. - *Strike out what does not apply.*



5. Naam of handelsmerk van alternatieve leveranciers die op de inrichting of het onderdeel zijn aangebracht :  
*Alternative supplier's names or trade applied to the device or component :* -
6. Naam en adres van het bedrijf of orgaan dat de verantwoordelijkheid voor de conformiteit van de productie op zich neemt :  
*Name and address of company or body taking responsibility for the conformity of production :* ALMIC BV  
 Bosuilstraat 7  
 B-3910 Pelt (Neerpelt)
7. Voor goedkeuring ter beschikking gesteld op :  
*Submitted for approval on :* 18/01/2022
8. Technische dienst die verantwoordelijk is voor de uitvoering van de goedkeuringstests :  
*Technical service conducting approval tests :*  
 ESTL nv  
 Wafelstraat 46  
 B-8540 Deerlijk
9. Korte beschrijving :  
*Brief description :*
- 9.1. Type en klasse van de inrichting of het onderdeel :  
*Type and class of device or component :* Type : BBV  
 Klasse : F
- 9.2. Karakteristieke waarden :  
*Characteristic values :*
- 9.2.1. Hoofdwaarden :  
*Primary values :*
- D: 31 kN      D<sub>c</sub>: --- kN      S: 350 kg      U: --- t      V: --- kN
- Alternatieve waarden :  
*Alternative values :*
- D: --- kN      D<sub>c</sub>: --- kN      S: --- kg      U: --- t      V: --- kN
- 9.3. Voor mechanische koppelinrichtingen en onderdelen van klasse A, inclusief trekhaken :  
*For Class A mechanical coupling devices or components, including towing brackets :*

Toelaatbare maximummassa van het voertuig volgens fabrieksopgave (kg):



*Vehicle manufacturer's maximum permissible vehicle mass (kg):*

Verdeling van de toelaatbare maximummassa van het voertuig over de assen:

as 1: kg  
as 2: kg

as 1: kg  
as 2: kg

*Distribution of maximum permissible vehicle mass between the axles:*

Toelaatbare maximummassa van de aanhangwagen volgens fabrieksopgave (kg):

*Vehicle manufacturer's maximum permissible towable trailer mass (kg):*

Maximale toelaatbare statische belasting op de koppelkogel volgens fabrieksopgave (kg):

*Vehicle manufacturer's maximum permissible static mass on coupling ball (kg):*

Maximummassa van het voertuig met carrosserie, in bedrijfsklare toestand, inclusief koelvloeistof, smeermiddelen, brandstof, gereedschap en reservewiel (indien meegeleverd), maar exclusief bestuurder (kg):

*Maximum mass of the vehicle, with bodywork, in running order, including coolant, oils, fuel, tools and spare wheel (if supplied) but not including driver (kg):*

Belading waarbij de hoogte van de trekkogel van een op voertuigen van klasse M1 gemonteerde koppelinrichting moet worden gemeten – zie bijlage 7, aanhangsel 1, punt 2:

*Loading condition under which the tow ball height of a mechanical coupling device fitted to categorie M1 vehicles is to be measured – see paragraph 2 of annex 7, appendix 1:*

10. Door de voertuigfabrikant gegeven instructies voor de bevestiging van het type koppelinrichting of een onderdeel ervan aan het voertuig en foto's of tekeningen van de bevestigingspunten :  
*Instructions for the attachment of the coupling device or component type to the vehicle and photographs or drawings of the mounting points given by the vehicle manufacturer :* See mounting instructions
11. Gegevens over de montage van afzonderlijke verstevigingsbeugels of -platen of afstandsonderdelen die nodig zijn om de koppelinrichting of het onderdeel ervan te bevestigen :  
*Information on the fitting of any special reinforcing brackets or plates or spacing components necessary for attachment of the coupling device or component :* See mounting instructions
12. Aanvullende gegevens indien de koppelinrichting of het onderdeel ervan slechts voor speciale voertuigtypen wordt gebruikt - zie



bijlage 5, punt 3.4 :  
*Additonal information where the use of the coupling device or component is restricted to special types of vehicles - see annex 5, paragraph 3.4. :*

N/A

13. Voor haakkoppelingen van klasse K, bijzonderheden over de trekogen die geschikt zijn voor gebruik met dit haaktype :  
*For Class K hook type couplings, details of the drawbar eyes suitable for use with the particulier hook type :*

N/A

14. Datum van het testrapport :  
*Date of test report :*

18/01/2022



15. Nummer van het testrapport : HCOUPL211110T1  
*Number of test report :*
16. Plaats van het goedkeuringsmerk : Left support  
*Approval mark position :*
17. Reden(en) voor de uitbreiding van de goedkeuring : N/A  
*Reason(s) for extension of approval :*
18. Goedkeuring verleend/~~uitgebreid~~/~~geweigerd~~/~~ingetrokken~~.<sup>2</sup>  
*Approval granted/~~extended~~/~~refused~~/~~withdrawn~~.<sup>2</sup>*
19. Plaats : Brussel  
*Place :*
20. Datum :  
*Date :*
21. Handtekening :  
*Signature :*

NAMENS DE SECRETARIS-GENERAAL:  
ON BEHALF OF THE SECRETARY-GENERAL:



R. VERHELST

22. De lijst van documenten die zijn ingediend bij de administratieve instantie die de goedkeuring heeft verleend is als bijlage bij deze mededeling gevoegd en is op verzoek verkrijgbaar.  
*The list of documents deposited with the Administration Service which has granted approval is annexed to this communication and may be obtained on request.*

---

<sup>2</sup> Doorhalen wat niet van toepassing is. - *Strike out what does not apply.*





Index bij het informatie pakket van een typegoedkeuring betreffende een Reglement

*Index to the information package of a type approval with regard to a Regulation*

Laatste toepasselijke Reglementering <i>Last applicable Series of amendments</i>	Nr. van de basis goedkeuring en bijwerkingsnr <i>Base approval and update n°</i>	Uitbreidingsnr <i>Extension n°</i>	Herzieningsnr <i>Revision n°</i>	Datum van uitgifte <i>Issue date</i>	Inlichtingenformulier <i>Information document</i>	
					Kenmerk <i>Reference</i>	Aantal blz. <i>Number of pages</i>
R55-02	00	---	---	Signature's date	TDHCOUPL211110T1	26

Gezien om gevoegd te worden bij het goedkeuringsformulier,  
*Approved and to be attached to the approval certificate,*



R. VERHELST



Index to the information package of a type approval with regard to a Regulation (UNECE) :

Last applicable Series of amendments	Base approval and update No	Extension No	Revision No	Issue date	Information document	
					Reference	Number of pages
R58-03	00	---	---	Signature date	TDHRUP211110T1	25

Approved and to be attached to the approval certificate,



R. VERHELST

Getekend op : 2022-02-16 14:51:43 +0100 te Brussel

dossier nr. 43001 - E6\*58R03/02\*0739\*00





Communication concerning :

- Approval granted <sup>(1)</sup>
- ~~- Approval extended <sup>(4)</sup>~~
- ~~- Approval refused <sup>(4)</sup>~~
- ~~- Approval withdrawn <sup>(4)</sup>~~
- ~~- Production definitively discontinued <sup>(4)</sup>~~

of a type of rear underrun protective device (RUPD), pursuant to Regulation No.58

Approval No : E6\*58R03/02\*0739\*00

Extension No : 00

1. Trade name or mark of device : ALMIC
2. Type of device : BBV
3. Name and address of manufacturer : ALMIC BV  
Bosuilstraat 7  
B-3910 Pelt (Neerpelt)
4. If applicable, name and address of the manufacturer's representative : -
5. Characteristics of the device (dimensions and its fixing elements) : See information folder
6. Test conducted on a vehicle / on a representative part of the chassis of a vehicle <sup>(1)</sup>.
7. Position on the device of the points of application of the test forces : P1: 975 mm from the middle  
P2: 350 mm from the middle  
P3: 0 mm from the middle
8. Maximum horizontal and vertical deflection observed during and after the application of the test forces in Annex 5 : During:  
Horizontal: 83mm  
Vertical: 55mm downwards  
After:  
Horizontal: <50mm  
Vertical: <50mm downwards
9. Restrictions on application  
Vehicles on which the device may be installed (if applicable) : See information folder  
Characteristics of the chassis to which the device may be installed (e.g. stiffness, profile dimensions, ...) (if applicable) : See information folder
10. Maximum mass of vehicle on which the device may be installed : Unlimited
11. Device submitted for approval on : 13/01/2022

Getekend op : 2022-02-16 14:51:43 +0100 te Brussel

dossier nr. 43001 - E6\*58R03/02\*0739\*00



12. Technical Service responsible for conducting approval tests: ESTL NV  
Wafelstraat 46  
8540 Deerlijk  
Belgium
13. Date of report issued by that service: 13/01/2022
14. Number of report issued by that service : HRUP211110T1
15. Approval has been granted / ~~refused~~ / ~~extended~~ / ~~withdrawn~~ in respect of the RUPD <sup>(1)</sup>
16. Position of approval mark on the device : Left support
17. Place : Brussels
18. Date : 16/02/2022
19. Signature :

ON BEHALF OF THE SECRETARY-GENERAL:



R. VERHELST

20. The following documents, bearing the approval number shown above, are available upon request:
- Drawings, diagrams and layout plans of the components of the structure considered to be of importance for the purposes of this Regulation;
  - Detailed information about the devices representing the vehicle structures used for the mounting of the RUPD (e.g. moment of inertia of the beams);
  - Where applicable drawings of the protective devices and their position on the vehicle.

(1) *Delete where not applicable*





**ESTL nv**  
Wafelstraat 46 -B 8540 Deerlijk  
**Automotive certification**  
homologation@estl.be

www.estl.be  
BTW 0818.634.666  
+32 (0) 56 77 86 00





<b>1. Report</b>	No.:	<b>HRUP211110T1</b>	Update:	00
	Ref.:	-	Annexes:	See Part 6.

<b>2. Test Subject</b>	Rear Underrun Protection Devices ( RUPDs) - Part I		
According to:	ECE R58-03	Supplement 2	EC 661/2009

<b>3. Information</b>			
Manufacturer:	Almic bvba Bosuilstraat 7 3910 Neerpelt Belgium		
Make of the RUPD:	ALMIC		
Type of the RUPD:	BBV		
Variants:	/		
Commercial description:	/		
Category(ies) :	O, N		

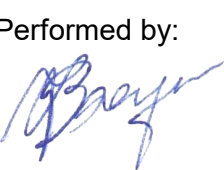
<b>4. Test</b>			
Place and date:	ESTL, Wafelstraat 46, Deerlijk, Belgium	25/05/2021	
Manufacturer's representative:	M. Marc Janssens		
Test Engineer:	Ing. Kristof Baeyens & Ing. Jeroen D'haese		
Technical documentation:	TDHRUP211110T1		
Location of E-mark:	See information folder		

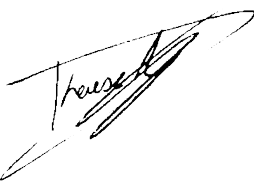
<b>5. Conclusions</b>			
The model represented fulfills the hereunder performed tests, as described in Regulation 58-03.			
Performed by:		Revised by:	
			
Ing. Kristof Baeyens & Ing. Jeroen D'haese Test Engineer		Ba. Matthias Vindevogel Test Engineer	
Date:	13/01/2022		

Report type :	Base report / Extension / Revision
Reason for extension / revision :	-
Scope for approval :	Individual / National series / International series
Test subject & scope:	Rear Underrun Protection Devices ( RUPDs) - Part I

### Part 1: Information test specimen

Make of the RUPD:	ALMIC
Type of the RUPD:	BBV
Commercial description:	-
Category(ies) :	O, N
Possible Variants:	-
Sample reception date:	25/05/2021
Worst case evaluation:	The system is tested at : *smallest/largest chassis width. *highest support length. *widest length. *smallest chassis inertia moment

### Part 2: General specifications

Par.	Subject	Result
5.2	The application for EU type-approval shall be accompanied by an information form, with detailed technical characteristics: *dimensions, and constituent materials *method of installation	Complies



### Part 3: Individual specifications

#### 3.0 General specifications

Par.	Subject	Result
7.1	The cross-member shall have a section height of at least 120 mm. The lateral extremities of the cross member shall not bend to the rear or have a sharp outer edge; this condition is fulfilled when the lateral extremities of the cross-member are rounded on the outside and have a radius of curvature of not less than 2.5 mm.	Complies
	RUPD intended to be fitted on vehicles of categories M, N1, N2 with a maximum mass not exceeding 8 t, O1, O2, on vehicles of category G and on vehicles fitted with a platform lift, the cross-member shall have a section height of at least 100 mm.	Not appl.
7.2	The RUPD may be so designed to have several positions at the rear of the vehicle. In this event, there shall be a guaranteed method of securing it in the service position so that any unintentional change of position is precluded. The force applied by the operator to vary the position of the device shall not exceed 40 daN.	Not appl.
	For RUPD that are designed to have several positions at the rear of the vehicle, a label shall be provided either with (a) symbol(s) or in the language(s) of the country where the device is sold to inform the operator about the standard position of the RUPD to offer effective protection against under-running. Label minimum size: 60x120mm	Not appl.

7.3	The RUPD shall offer adequate resistance to forces applied parallel to the longitudinal axis of the vehicle. (This shall be demonstrated in accordance with the test procedure and test conditions specified in Annex 5 to this Regulation.) The maximum horizontal deflection of the RUPD observed during and after the application of the test forces specified in Annex 5 shall be recorded on the type approval communication (Annex 1, item 8).	Complies
7.4	For vehicles fitted with a platform lift at the rear, the underrun device may be interrupted for the purposes of the mechanism. In this case, the following special requirements apply:	
7.4.1	The maximum lateral clearance measured between the elements of the underrun device and the elements of the platform lift, which move through the interruption when the lift is operated and which make the interruption necessary, may amount to no more than 2.5 cm.	Not appl.
7.4.2	The individual elements of the underrun protection, including those outboard of the lift mechanism, where provided, must have an effective surface area, in each case, of at least 420 cm <sup>2</sup> .	Not appl.
7.4.3	For cross-members with a section height of less than 120 mm, the individual elements of the underrun protection, including those outboard of the lift mechanism, where provided, shall have an effective surface area, in each case, of at least 350 cm <sup>2</sup> .	Not appl.
7.4.4	In the case of vehicles having a width of less than 2,000 mm and where it is impossible to achieve the requirements of paragraphs 7.4.2. and 7.4.3., the effective surface may be reduced on the condition that the resistance criteria are met.	Not appl.

### 3.1 Dimensional specifications

Par.	Dimension	Value	
	Wider rear axle width	2550	mm
	Cross-member width	2350	mm
	Transverse distance between brackets: min	760	mm
	Transverse distance between brackets: max	860	mm
	Difference in transverse distance	100	mm
	Width difference on the left side (≤100mm)	 100	mm
	Width difference on the right side (≤100mm)	 100	mm

## Part 4: Physical test

### 4.0 Test method

A5 1.4	If the cross-member does not have a vertical flat surface of at least 50 % of the minimum section height at the test force height, a device that doesn't modify the dimensional and mechanical characteristics of the RUPD or increase its resistance is used. The device shall neither be rigidly fixed to the RUPD nor to the test equipment.	Complies
A5 1.3	The test procedure may be simulated by calculation. A validation report shall be drafted by the manufacturer or by the technical service and submitted to the Type Approval Authority.	Not appl.

A. Rigid test bench	Complies	
A5 1.1.2	RUPD is tested /calculated on a rigid test bench.	Complies

A5 1.2	RUPD is tested on a test bench with a part of chassis of the vehicle type. The parts used to connect the RUPD to the vehicle chassis shall be equivalent to those which are used to secure the RUPD when it is installed on the vehicle. The distance of the foremost fixing point of the RUPD from the rigid test bench shall not be less than 500 mm.	Complies
--------	---	----------

B. Vehicle test		Not appl.
A5 2.1	The vehicle shall be at rest on a level, flat, rigid and smooth surface.	Not appl.
A5 2.2	The front wheels shall be in the straight-ahead position.	Not appl.
A5 2.3	The tyres shall be inflated to the pressure recommended by the vehicle manufacturer.	Not appl.
A5 2.4	The vehicle may, if necessary to achieve the test forces required in § 3.1. below, be restrained by any method.	Not appl.
A5 2.5	Vehicles equipped with hydropneumatic, hydraulic or pneumatic suspension or a device for automatic levelling according to load shall be tested with the suspension or device in the normal running condition specified by the manufacturer.	Not appl.

#### 4.1 Chassis

Minimal moment of inertia of chassis members (one chassis beam) [mm <sup>4</sup> ]	57071940
--	----------

#### 4.2 Height regulation device test

7.2	If the RUPD is designed to have several positions at the rear of the vehicle, there must be a guaranteed method of securing it in the service position so that any unintentional change of position is precluded. Force applied by the operator to change position ≤ 40 daN.	<input checked="" type="checkbox"/>	N/A	N
7.2	Aa label shall be provided either with (a) symbol(s) or in the language(s) of the country where the device is sold to inform the operator about the standard position. Label min. size: 60 x 120 mm			Complies

#### 4.3 Load test dimensions

Par.	Point	Horizontal transverse position	
A5 3.1.2	P1	975	mm from the middle
A5 3.1.3	P2	350	mm from the middle
A5 3.1.1	P3	0	mm from the middle

#### Informative

A5 3.2.1	Replacement force if point in interruption area (Platform lift) * P2: replacement point: within 50mm to the intended points * P1: replacement point: max. 325mm from outer edges of the wheels on the rear axle
	Test point height ≤ 600mm above the ground. (If tested on a vehicle)

#### 4.4 Load test forces

Techn. perm. maximum mass vehicle:	Unlimited	kg
If special vehicle: 80% of nominal value [A5 §3,1,3]	100	%



Moment of inertia of chassis members (one chassis beam) [mm <sup>4</sup> ]				57071940	
Point	Specified Load [daN]		Deflection [mm]		
	A5 §3	Max. Applied Load [daN]	Horizontal	Vertical	
Point P1	10000	10010	82	53	
Point P2	18000	18000	42	36	
Point P3	10000	10020	6	6	
Point P2	18000	18010	45	40	
Point P1	10000	10030	79	48	

#### 4.4.2 Calculated displacements with other chassis member

Moment of inertia of chassis members (one chassis beam) [mm <sup>4</sup> ]				34270923	
Point	Specified Load [daN]		Deflection [mm]		
	A5 §3	Max. Applied Load [daN]	Horizontal	Vertical	
Point P1	10000	10000	83	55	
Point P2	18000	18000	43	38	
Point P3	10000	10000	7	8	
Point P2	18000	18000	46	42	
Point P1	10000	10000	80	50	
Remark:	WORST CASE TEST= HRUP210525T1, test results transmitted				

#### 4.5 Result

		Horizontal	Vertical
7.3	Max. deflection [mm] A1 Pt. 8	83	55

### Part 5: Conclusions and remarks

-The dimensional requirements are to be evaluated after installation.  
 - A modified construction is developed, based upon the approved original type BVR of 25/05/21 with approval number E6-58R03/00\*0684\*00 The modified construction permits the mounting of a tow ball through a separate R55 approval.  
 The performed tests on the original type of are applicable since the modified construction has a comparable construction, but a stiffer and stronger connection method, resulting in less deformation during an R58 test.

### Part 6: Annexes

No.	Description	# Pages
-	-	-

### Part 7: Used test equipment

Description	Registration number	Calibrated	Applicable
Length meter	T_LMT_5m_05	x	x
Force controller	UTMC_02 MCIL_D60100450_01	x	x
Load cell	LC_99K_03	x	x
Digital angle meter	T_DHM_07	x	
Digital protractor	T_DSMM_03	x	x
Radius caliper	CAL_R2,5_01	x	x
Displacement measurement device	T_LTK_1.25m_04&05	x	x
-	-	-	-



**ESTL nv** www.estl.be  
Wafelstraat 46 -B 8540 Deerlijk BTW 0818.634.666  
**Automotive certification**  
homologation@estl.be +32 (0) 56 77 86 00





<b>1. Report</b>	No.:	<b>HCOUPL211110T1</b>	Update:	00
	Ref.:	-	Annexes:	See Part 6.

<b>2. Test Subject</b>	Coupling device
According to:	ECE R55-02 Supplement 0 EC 661/2009

<b>3. Information</b>	
Applicant for approval:	Almic BVBA Bosuilstraat 7 3910 Pelt (Neerpelt) Belgium
Make of the device:	Almic
Type and commercial description:	BBV
Class of device:	F

<b>4. Test</b>		
Place and date:	ESTL, Wafelstraat 46, B-8540 Deerlijk	10/11/2021
Manufacturer's representative:	M. Marc Janssen	
Test Engineer:	Ing. Kristof Baeyens & Ing. Jeroen D'haese	
Technical documentation:	TDHCOUPL211110T1	
Location of E-mark:	Left support	

<b>5. Conclusions</b>	
The model represented <b>fulfills</b> the hereunder performed tests, as described in UN ECE R55.	
Performed by:	Revised by:
 Ing. Kristof Baeyens & Ing. Jeroen D'haese Test Engineer	 Ba. Matthias Vindevogel Test Engineer
Date:	18/01/2022



Report type : Base report / ~~Extension~~ / ~~Revision~~  
 Reason for extension / revision: -  
 Scope of this report: Individual vehicle approval/International series/National series  
 Transitional provisions: New approval requests: from 1/09/2021, at least R55-02

**Part 0: Reason for testing and vehicle description**

A new type of coupling is to be evaluated.

**Part 1: Test conditions**

Sample reception date:	12/10/2021
Worst case evaluation:	-Largest chassis width -highest support length -Maximum horizontal extension

**Part 2: General information test specimen**

2.0 Standard information

- 1.1 Technical description file
- 1.2 Class of coupling
- 1.3 Permissible D-value  
Permissible Dc-value
- 1.4 Permissible vertical mass on the coupling S
- 1.5 Permissible vertical mass on the fifth wheel coupling
- 1.6 Permissible V-value
- 1.7 Mounting instructions
- 1.8 Instructions on the mounting of mounting plates

TDHCOUPL211110T1	
F	
31	kN
-	kN
350	kg
-	Tonnes
-	kN
See technical documentation	
See technical documentation	

2.1 Dimensional check of coupling component class B,C,D,G,K,L,T

The couplings dimensions fulfill the dimensional requirements as stated in Annex 5 of ECE R55-01.	NOT APPLICABLE
Dimensional requirements covered by report:	N.A.

**Part 3: Requirements**

3.0 General requirements

Par.	Subject	Result
§3.2.3	For towing devices intended for M1 or N1 vehicle, a statement of the maximum permissible towing vehicle and trailer masses and the maximum permissible static vertical imposed load on the towing device as advised by the manufacturer of the towing vehicle; if the value for the maximum permissible towable mass is zero or no value declared by vehicle manufacturer, the application for approval shall be refused.	NOT APPLICABLE
§3.2.8	In the case of a mechanical coupling device or component designed for a specific vehicle type, the manufacturer of the device or component shall also submit the installation data.	NOT APPLICABLE
§4.2	All parts of the mechanical coupling device or component whose failure could result in separation of the vehicle and trailer shall be made of steel.	COMPLIES

§7.2	An approval mark with the type approval number, the coupling class and the characteristic values are visualised.	COMPLIES
§7.5	If the application of the mechanical coupling device or component is restricted in any way, for example, if it is not to be used with steering wedges, then that restriction shall be marked on the device or component.	NOT APPLICABLE
§4.5	Mechanical coupling devices shall be designed to have positive mechanical engagement and the closed position shall be locked at least once by further positive mechanical engagement unless further requirements are stated in A5. Alternatively there may be 2 or more separate arrangements to ensure the integrity of the device. Each arrangement shall have positive mechanical engagement and comply to A6. Positive mechanical engagement shall be as defined in § 2.14. Spring forces may be used only to close the device and to prevent the effects of vibration from causing component parts of the device to move to positions where it may open or disengage. The failure or omission of any one single spring shall not allow the complete device to open or disengage.	NOT APPLICABLE
§2.14	“Positive mechanical engagement” : design and geometry shall be such that it will not open or disengage under the action of any forces or components of forces to which it is subject during normal use or testing.	NOT APPLICABLE
§4.6	Every device or component shall be accompanied by installation and operating instructions giving sufficient information for any competent person to install it correctly on the vehicle and operate it properly.	COMPLIES
§4.7	For devices and components of Class A, Class K or Class S, for use with trailers of MPM not exceeding 3,5 tons, the height and other installation features of the coupling shall, in all cases, be verified by the type approval authority or technical service in accordance with Annex 7, paragraph 1.	NOT APPLICABLE
§4.8	Towing brackets/drawbeams which are intended to tow trailers up to 3,5 t shall incorporate attachment points, to which either secondary couplings or devices necessary to enable the trailer to be guided and/or stopped automatically in the event of separation of the main coupling, may be attached.	COMPLIES
§4.8.1	The attachment points for a secondary coupling and/or breakaway cable shall be positioned such that when in use, the secondary coupling or breakaway cable does not restrict the normal articulation of the coupling or interfere with the normal inertia braking system operation. A single attachment point shall be positioned within 100 mm of a vertical plane passing through the centre of articulation of the coupling. If this is not practicable, two attachment points shall be provided, one on each side of the vertical centre line and equidistant from the centre line by a maximum of 250 mm.	COMPLIES
A5 §9.2	Mounting plates for non-standard fifth wheel couplings which are unsuitable for positive steering shall be marked.	NOT APPLICABLE

A6 §1.7	Any positive locking device, which is retained in position by spring force, shall remain in its secured position when subjected to a force applied in the least favourable direction and equivalent to three times the mass of the lock mechanism.	NOT APPLICABLE
A6 §3.1.7.	In the case where detachable ball units are retained using fixing arrangements other than screwed fittings, for example, spring clips, and where the positive mechanical engagement aspect of the arrangement is not tested during the dynamic test, then the arrangement shall be subject to a static test applied to the ball or to the positive mechanical engagement arrangement in an appropriate direction. Where the positive mechanical engagement arrangement retains the ball unit vertically, the static test shall be to apply an upwards vertical force to the ball equivalent to the "D" value. Where the positive mechanical engagement arrangement retains the ball unit by means of a transverse horizontal design, the static test shall be to apply a force in this direction equivalent to 0.25 D. There shall not be any failure of the positive mechanical engagement device or any distortion likely to have an adverse effect on its function.	NOT APPLICABLE

*3.1 Specific requirements for class A & F*

A5 § 1.1	Coupling balls of Class A shall conform to Figure 2 in external shape and external dimensions.	NOT APPLICABLE
A5 § 1.7	Manufacturers of coupling balls and towing brackets intended for fitment in the after-market and which do not have any association with the relevant vehicle manufacturer shall be aware of the requirements for articulation of the coupling. When not attached to the vehicle, horizontal rotation of the coupling head shall be at least 90° to each side of the centre line of the coupling ball and mounting described in paragraph 1 of this annex. Simultaneously, there shall be an angle of free vertical movement 20° above and below the horizontal. Also, in conjunction with the horizontal angle of rotation of 90° it shall be possible for there to be 25° of roll in both directions about the horizontal axis. The following articulation shall be possible at all angles of horizontal rotation: (a) Vertical pitch ± 15° with axial roll ± 25° (b) Axial roll ± 10° with vertical pitch ± 20°	COMPLIES

<p>A7 § 1.1.1</p>	<p>Coupling balls, hook coupling and towing brackets shall be attached to vehicles of categories M1, M2 (below 3,5 t MPM) and N1 conform to the clearance and height dimensions given in Figure 25. The height shall be measured at the vehicle loading conditions of the appendix.</p>	<p>NOT INVESTIGATED</p>
<p>A7 § 1.1.4</p>	<p>When the trailer is not coupled to the towing vehicle, the mounted towing bracket and coupling ball shall not (partly) obscure, within the planes of geometrical visibility, any lighting component (e.g. rear fog lamp) or the space for mounting and the fixing of the rear registration plate of the towing vehicle, unless the installed mechanical coupling device can be removed or repositioned without the use of any tools, except an easily operated (i.e. an effort not exceeding twenty (20) Nm) release key which is carried in the vehicle.</p> <p>If the installed mechanical coupling device is capable of (partly) obscuring any lighting component and/or space for mounting and the fixing of the rear registration plate of the towing vehicle, this shall be duly noted in the test report and clearly stated under 'Remarks' on the vehicle type approval communication form.</p> <p>If an alternative location for the space for mounting and the fixing of the rear registration plate of the towing vehicle and/or any lighting device is specified by the vehicle manufacturer in the context of a mechanical coupling device (partly) obscuring either one or both, this shall be duly noted in the test report and clearly stated under 'Remarks' on the vehicle type approval communication form.</p>	<p>NOT INVESTIGATED</p>

**Part 4: Physical test**

**4.0 Test requirements**

Par.	Subject	Result
<p>A6 §2.2</p>	<p>The test frequency shall not exceed 35 Hz. The selected frequency shall be well separated from resonance frequencies of the test set up including the tested device. With asynchronous testing the frequencies of the two force components shall be between 1 % and max. 3 % apart. For devices made from materials other than steel a higher number of cycles may be necessary</p>	<p>COMPLIES</p>
<p>A6 §2.2</p>	<p>The dye-penetration method of crack testing or an equivalent method shall be used to determine any cracking during test.</p>	<p>COMPLIES</p>

A6 §2.1	In the case of alternating tests, the direction of force application shall not deviate by more than $\pm 1^\circ$ from the specified direction.	COMPLIES
A6 pict.21	I.c.o. class A, F for ball coupling: test performed under:	+15°
A6 §2.2	For coupling devices made from steel the number of stress cycles is $2 \times 10^6$ .	COMPLIES
A6 §2.5	The coupling devices or component on test should normally be mounted as rigidly as possible on a test rig.	COMPLIES

4.1 Test settings

4.1.0 Mounting conditions

	The coupling shall be installed conf. the installation requirements (fixation points) of the vehicle manufacturer.	COMPLIES
§4.7	For devices and components of Class A, Class K or Class S, if applicable, for use with trailers of maximum permissible mass not exceeding 3,5 tons, and which are produced by manufacturers not having any association with the vehicle manufacturer and where the devices and components are intended for fitting in the after-market, the height and other installation features of the coupling shall be verified.	NOT APPLICABLE

4.1.1 Repetitive test

Applied Loads @ coupling	Resultant	horizontal towards front /rear	horizontal towards right/left	vertical up/down
Fmin [kN]	-18,6			
Fmax [kN]	18,6			
F0 [kN]	0			
Freq. [Hz]	6,5			
Start date:	10/11/2021	End date:	17/11/2021	

4.1.2 Carlos test

4.2 Test results

4.2.1 Repetitive test

A6 §1.3	No cracks or fractures, verified with dye penetration method.	COMPLIES
4.1	No any excessive permanent distortion which is detrimental.	COMPLIES

4.2.2 Carlos test

A6 § 3.10.4	The coupling shall not have any visible plastic deformation.	NOT APPLICABLE
	No functionality and safety of the coupling is affected(e.g. safe connection of the trailer, maximum play).	NOT APPLICABLE
	No torque loss of the bolts exceeding 30 per cent of the nominal torque measured in the closing direction.	NOT APPLICABLE
	A coupling device with detachable part can be detached and attached for at least 3 times. For the first detachment, one impact is permitted.	NOT APPLICABLE

4.2.3 Lifting test

A6 § 3.7.2.2	There shall not be a separation between the coupling devices.	NOT APPLICABLE
	Lifting force: 0 kN	

4.2.3 Bending test

A6 § 3.7.2.1	Plastic deformation is less than 0,5%.	NOT APPLICABLE
A6 § 3.7.2.2	There shall not be any cracking in the coupling.	NOT APPLICABLE

**4.2.4 Static test**

A6 §1.4	Permanent deformation after releasing <10% max. deformation during test.	NOT APPLICABLE
	Permanent deformation i.c.o. static test [mm]	NOT APPLICABLE

**Part 5: Conclusions and remarks**

Sampling is performed by the customer. The information of the Information document is received from the customer. Dimensional specifications are checked by ESTL. Certain specifications (e.g. material specifications) are not evaluated by ESTL.

Mounting requirements to be evaluated after mounting on a vehicle.

**Part 6: Annexes**

No.	Description	# Pages
-		

**Part 7: Used test equipment**

Description	Registration number	Calibrated	Applicable
Loadcell	LCV_5T_03	x	x
Controller	VTB_01	x	x
Torque wrench	T_MMSLTL_07	x	x
Digital lever device	T_DHM_08	x	x
length caliper	T_DSMM_05	x	x
Length meter	T_LMT_5m_08	x	x

End of test report